



SPYDER RTR MID SWX2

1/10 scale Ready To Race electro Buggy 2WD

INSTRUCTION MANUAL & REFERENCE GUIDE



powered by



Introduction

Thank you very much for buying this Serpent rc car. You are now member of a large following of Serpent fans worldwide. This Serpent car will bring you many hours and weekends of racing excitement.

Serpent started as rc racing company in 1980, and has developed many modelcars since. This wealth of experience and know how is used in our todays cars and that shows!

The Serpent Spyder series of cars is the best entry in the world of rc racing. Affordable and a very good basis to start your racing carreer. The Serpent Spyder RTR is based on the high-end competition version of the Spyder and shares geometry and many parts. Still its easy to use, maintain and set up. The RTR Spyder is fully upgradable to high end competition spec. The details can be found in our website.

Designed, tested and raced by Billy Easton, USA. World Champion.

This manual contains a number of steps you need to follow to operate the Serpent cars in the right way. This manual also contains a quick-start section, a partslist and exploded views, and a FAQ section. A full assembly manual can be found online in the Serpent.com website. So read this manual with great attention before racing this car. For your own safety as well as for others, and to ensure you can enjoy your Serpent car a long time, even if you are an experienced user. Serpent is not only about the car itself. Serpent as company, and the worldwide network or distributors and dealers are here to help you out.

The Serpent website and social media are available for assistance and additional information as well.

Enjoy your Serpent, the racing experience!

Contents

Introduction	
Read this first	2
Safety matters	3
Quickstart	3
Required equipment	4
Model specs / overview	5
Basic Tuning	6
Maintenance	7
Exploded views	8
Partslist	14

Read this first

- This is a highly technical hobby product, intended to be used in a safe racing environment. This car is capable of speeds in excess of 70 km/h or 50mph.
- Please follow these guidelines when building and operating this model.
- Parental guidance is required when the builder/user of this car is under 16.
- Follow the building instructions. If in doubt, contact your dealer or importer.
- Be sure to use the proper tools when assembling the car. Always exercise caution when using electric tools, knives and other sharp objects.
- Be careful when using liquids like lubrication oil or glue. Do not swallow. Follow the manufacturer's instruction in case you experience irritation after using the product.
- Be careful when operating the car. Stay away from any rotating parts such as wheels, gears and transmission.
- Stay away from speedo during and immediately after use, as these parts may be very hot. We advise to use protective handgloves.
- Only operate this car in a safe environment, like a special racing track or a closed parking lot.
- Avoid using this car on public roads, crowded places or near infants.
- Before operating this car, always check the mechanical status of the car. Check that the batteries of the transmitter and receiver are fully charged. After use, always check all the mechanics of the car. We advise to clean the car immediately after use, and inspect the parts for wear or fractures. Replace when necessary. Do not use water, methanol, thinner or other solvents to clean the car.
- Store the car in a dry and heated place to avoid corrosion of metal parts.
- Avoid using this car in wet conditions as the water will cause corrosion on the metal parts and bearings and these parts will cease to function properly. If driven in the wet, ensure that all the electric equipment is waterproofed and after use, that all moving parts are dried immediately.

Safety matters

All instructions in this manual must be followed to ensure safe use of the car. This model is not intended for use by children under 14 years .

Important pre-cautions

- Only run the car in designated areas or areas with very few people, so no-one can get hurt.
- The car has a lot of power and the turning parts on the car can cause damage, also some parts of the car like transmission and motorparts can become very hot. So wear protective clothing both as driver and helper and be careful when picking up the car.
- Do not operate the car under dark conditions, as both you and others may not see the car properly and can get hurt, due to lack of car control.
- Use good common sense while operating the car so you can fully enjoy your car.

Battery and battery-charging

- The battery and battery-charger are not included with this model. We advise to use good quality NimH or Lipo rechargeable battery-packs with 4000 mA or more. Check carefully to buy batteries with the correct connector for the speedcontroller, or also purchase and mount other fitting ones.
- Use proper battery-charger specifically designed for that type batteries and follow the instructions of the battery supplier and the charger correctly.
- Keep the battery and charger always in dry places only and never leave un-attended during charging.
- When the batteries are at their end of life, dispose them at a recycling-place, check www.call2recycle.org for more info.

Quick-start

The quick-start section is not a replacement for the full instructions. To be able to use the model to its best take the time to read the full manual.

1. Read the manual and safety pre-cautions (page 4)
2. Buy and install the batteries in the transmitter (see Transmitter manual)
3. Install the battery pack in the model, make sure the speedo is switched off, connect the cables (avoid reversed polarity) and securely fasten the battery-pack.
4. Turn on the transmitter (see Transmitter manual). Always turn on the transmitter first before to switch on the car and only turn off the transmitter after you switched off the car.
5. Check servo operation. Check that the servo works correctly and check that the car runs straight in neutral position, trim as needed. Perform a range test with the radio system
6. Personalise the body of your car by applying more decals if required.
7. Drive your modelcar.
8. Maintain your modelcar (page 9)

Equipment



Included with your model:

- Serpent modelcar, factory assembled and set-up
- Dragon-RC DTS-2 transmitter (as shown or similar)
- Dragon-RC DESC speedcontroller
- Dragon-RC brushless motor
- Dragon-RC racing tyres, pre-mounts
- Dragon-RC digital servo
- Serpent pretrained and pre-cut bodyshell



Required for your model

- Multi Charger; to charge transmitter battery and car battery
- Battery pack 2-S Lipo
- Battery AA x 4 to operate the transmitter
- Tools: selection of allen tools and screw- drivers
- Hobby knife
- Camber gauge

Recommended materials

- Side cutter and nose plier
- Cleaning brush and towel
- Safety glasses and gloves
- Cleaning gum
- Thin bearing oil
- Transmission grease
- CA glue
- Degreaser

Model specs/overview

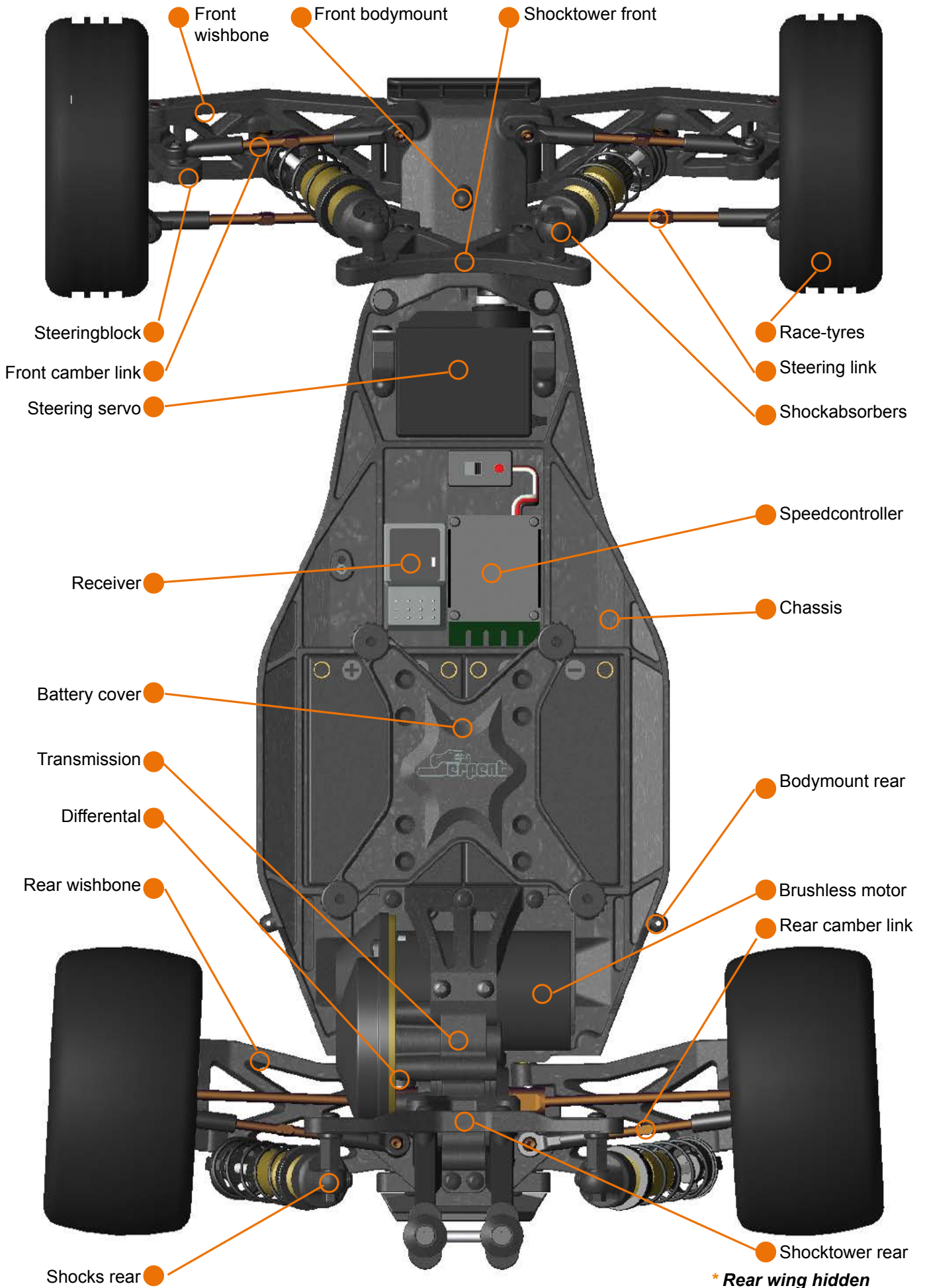

Basic tuning

- **Springs:** by using a softer spring you will have more sag, more chassis roll/lean, more dive and a less responsive car this might be better on low-grip surfaces; by using a harder spring you have less sag, less body lean, less dive and a more responsive car. What to apply depends on driving style and grip-level surface. This is more suitable on high-grip surfaces.
- **Shock-angle:** the angle at which the shocks are mounted create a different suspension feel; the more vertical, the harder it feels, the more horizontal, the softer it feels.
- **Oil:** the viscosity of the shock-oil defines the dampening of the shockabsorber. Thinner oil will be softer, with slower response, thicker oil will be harder dampening with faster reponse. The dampening can also be fine-tuned by fitting other pistons with more or less holes, which is an optional.
- **Differential:** you can make the gear differential harder or softer by using a different oil viscosity. Lighter oil will create a looser diff which increases rear traction on acceleration, but also more understeer, and a harder differential will decrease rear traction on acceleration, but also more on-throttle steering
- **Toe adjustment:** Front: adjusted with the track-rods, make longer or shorter. More toe-in will create more steering, but less stability; toe-out will create a more stable car, with less steering.
- **Toe adjustment:** Rear: adjusted with suspension blocks (optional). More toe-in will create more traction, more stability, but less speed. Less toe in will create a less stable car, with less traction but higher speed.
- **Front camber:** using more negative camber in the front will give you more steering but also increases possible traction roll.
- **Rear camber:** using more negative camber in the rear will create more grip in the rear meaning also creating more understeer.
- **Front caster:** use optional caster blocks to change caster, more caster will create more steering but also increases possible traction roll. And less caster will create less steering but also decreases possible traction roll.
- **Wheel-base length:** a longer car will be more stable and react slower, a shorter car will be more nervous and more direct.
- **Gear-ratio:** spur and pinion: for correct gearmesh keep a pieces of notebook paper at hand, to put between the spur and pinion for correct mesh.
- **Ride-height:** you can change the ride-height of the car, by applying more or less pre-load on the springs, turn the pre-load adjusters to set the desired height and keep left and right the same.
- **Set-up sheets**
The set-up sheets for this car, default and editable, can be found here:
<http://serpent.com/product/500006/setups/>
and set-ups from the race/kit version are here:
<http://serpent.com/product/500003/setups/>

Springs



Shock angle



Front Toe-out



Rear Toe-in

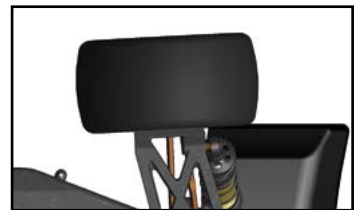

Front camber



Rear camber

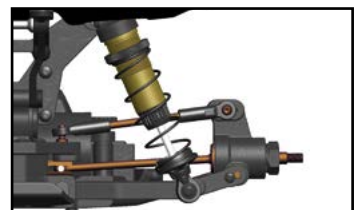

Gear-ratio

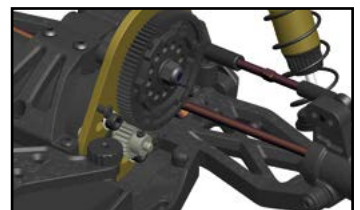

Ride Height

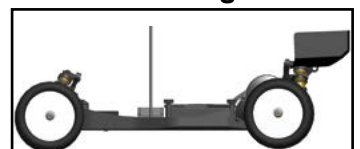

Maintenance

- **Shockabsorbers**

Check for smooth operation of the shockabsorbers, and check for airbubbles by pushing the shock up and down fast after removal of the spring. Clean the shockabsorbers as needed and refill with fresh 100% pure silicone oil as needed.

- **Tyres**

Replace tyres if case worn or damaged, and clean the surface in case dirty to obtain better grip.

- **Wheel-axes and driveshafts**

Remove the wheels, and check the wheel-axes, driveshafts and pins. Clean thoroughly as needed and lubricate the touching parts with a small amount of grease or oil.

- **Differential**

Check the differentials and gears for wear and dirt and clean as needed. Check the functioning of the diff by turning the wheels in opposite direction and feel if still smooth or 'gritty'. In case of gritty feel, the silicone oil may need replacement.

The full assembly manual of this model is available online; check on www.serpent.com and type your modelnumber, partnumber, or select your car from the car-page; go to the download section in the menu and download the full manual.

Shockabsorbers

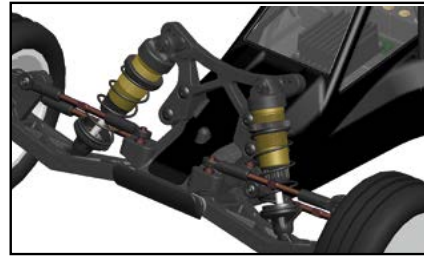

Tyres

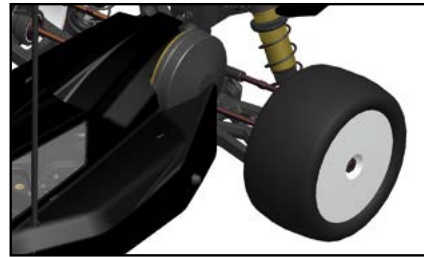

Wheel-axes and driveshafts



Differentials

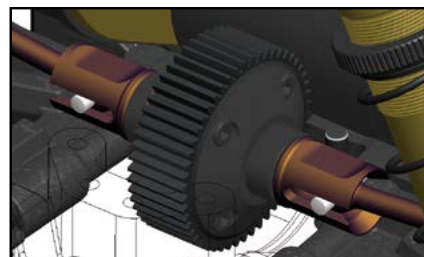

EXPLODED VIEWS WITH PART NUMBERS

FRONT ASSEMBLY-1

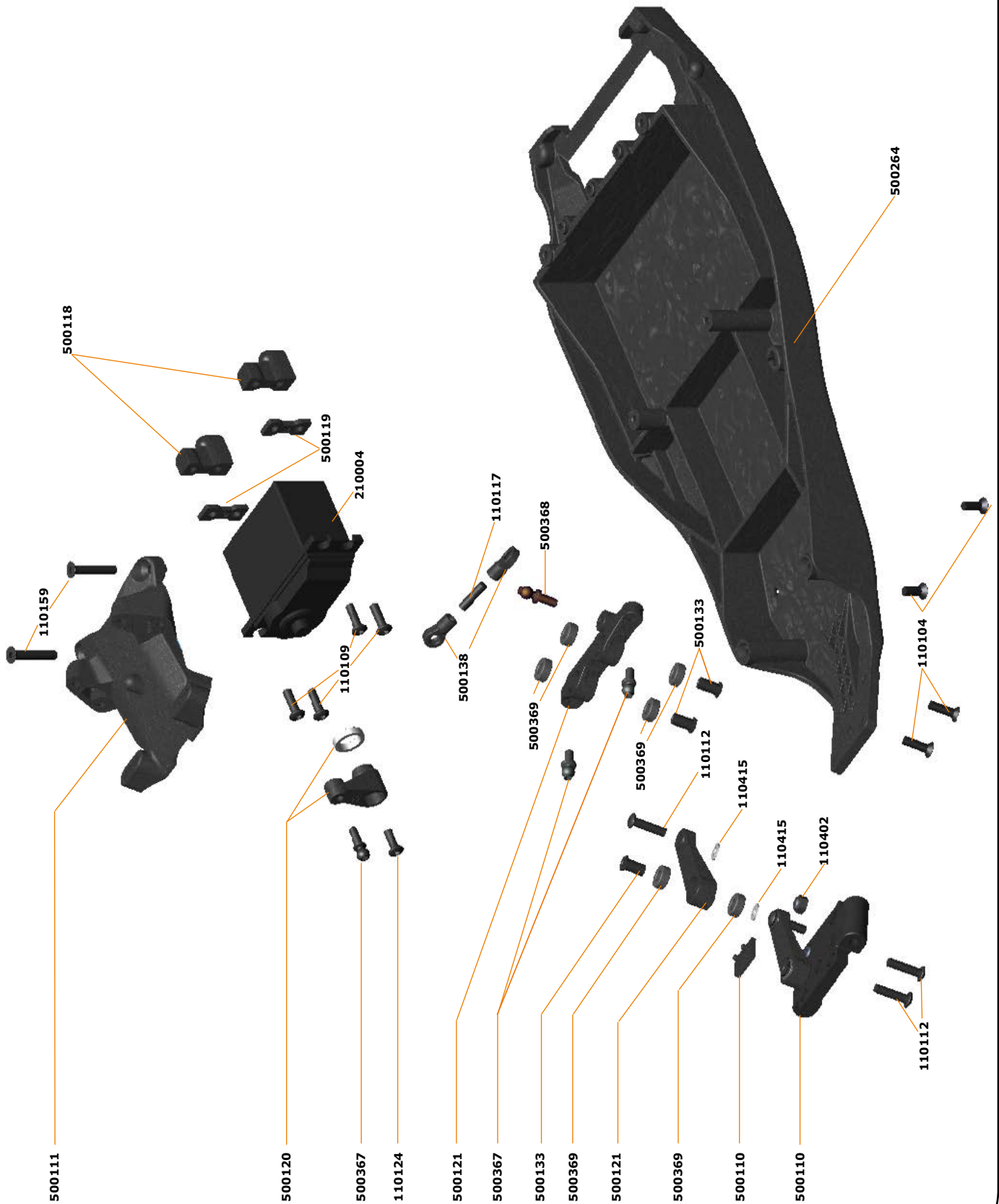

FRONT ASSEMBLY-2

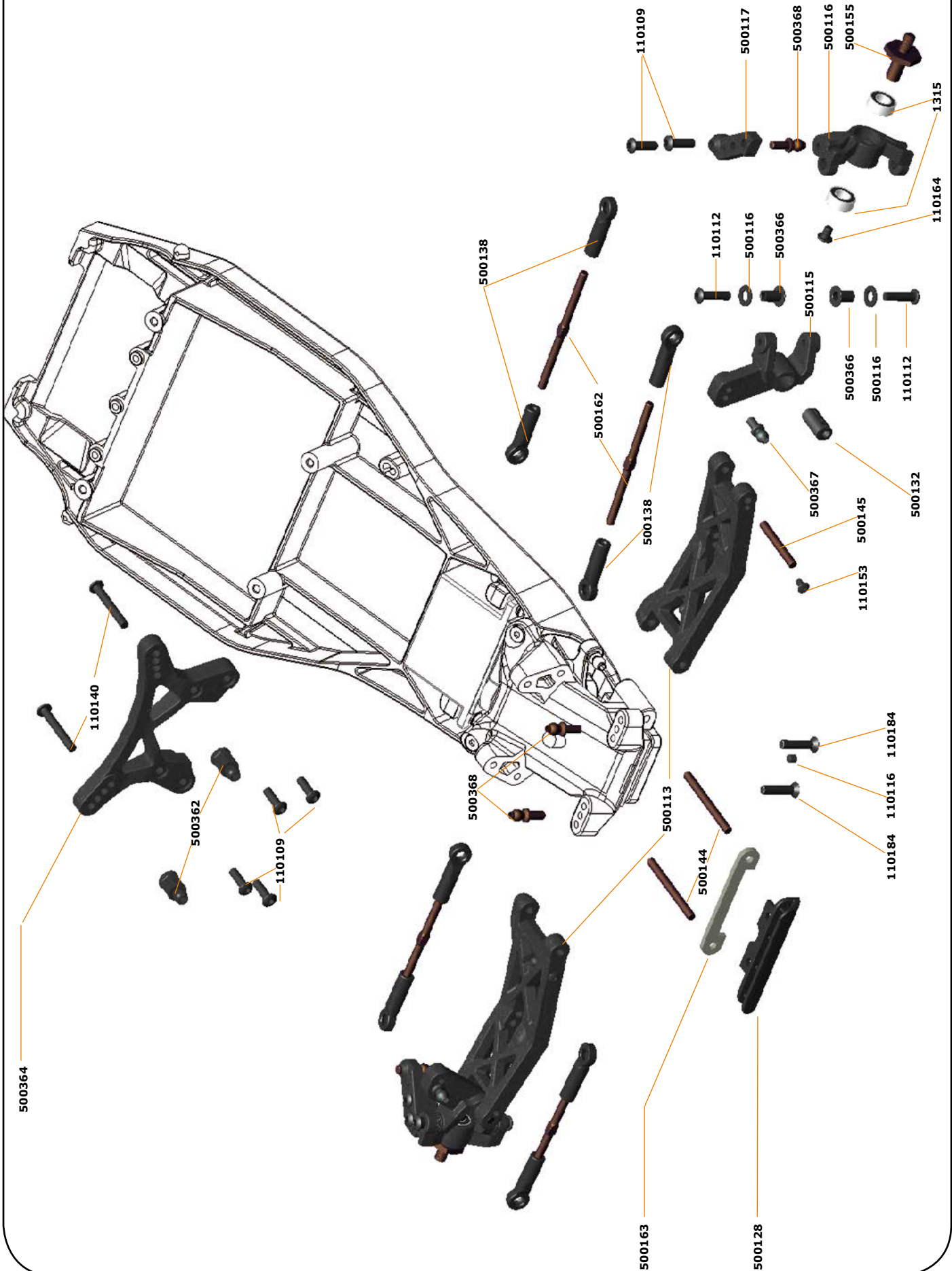

GEAR-DIFF EXPLODED VIEW

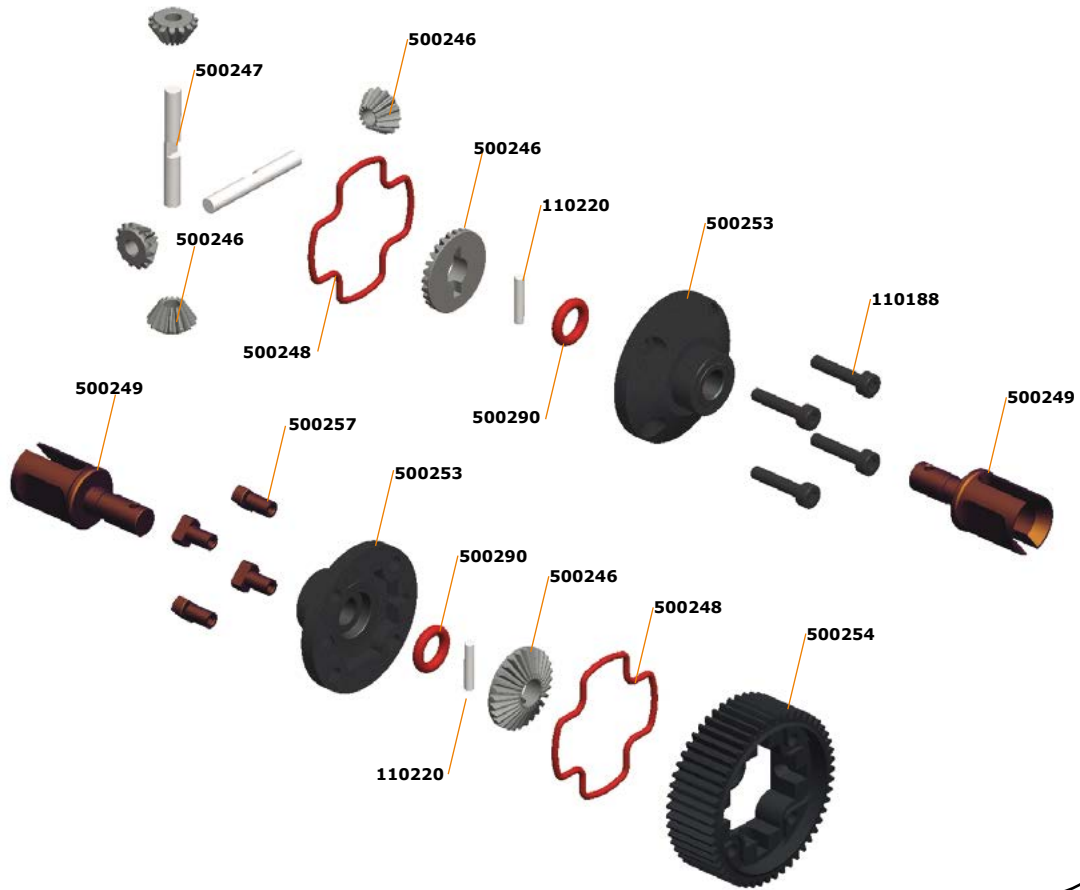

SHOCKS ASSEMBLY

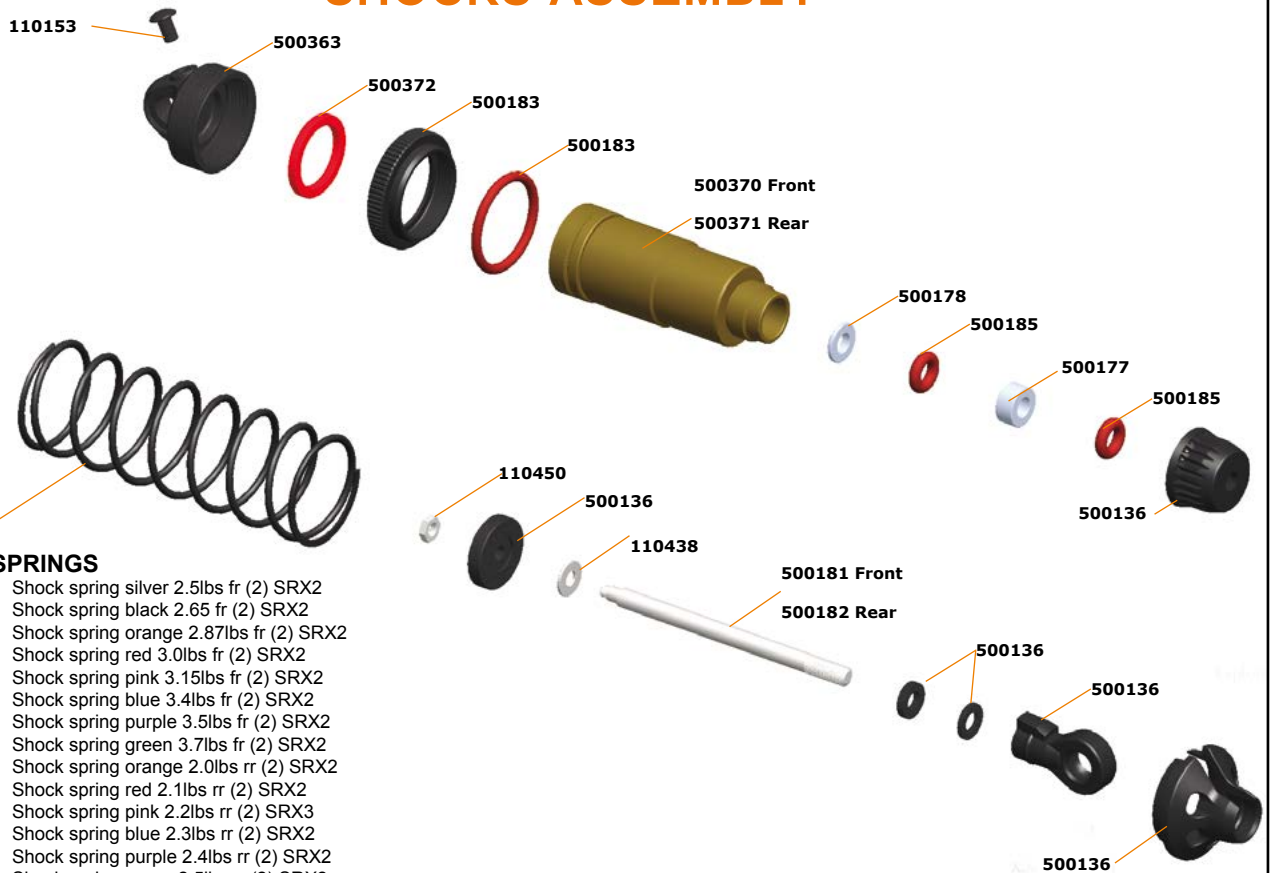

SHOCK SPRINGS

- 500222 Shock spring silver 2.5lbs fr (2) SRX2
- 500223 Shock spring black 2.65 fr (2) SRX2
- 500224 Shock spring orange 2.87lbs fr (2) SRX2
- 500225 Shock spring red 3.0lbs fr (2) SRX2
- 500226 Shock spring pink 3.15lbs fr (2) SRX2
- 500227 Shock spring blue 3.4lbs fr (2) SRX2
- 500228 Shock spring purple 3.5lbs fr (2) SRX2
- 500229 Shock spring green 3.7lbs fr (2) SRX2
- 500230 Shock spring orange 2.0lbs rr (2) SRX2
- 500231 Shock spring red 2.1lbs rr (2) SRX2
- 500232 Shock spring pink 2.2lbs rr (2) SRX3
- 500233 Shock spring blue 2.3lbs rr (2) SRX2
- 500234 Shock spring purple 2.4lbs rr (2) SRX2
- 500235 Shock spring green 2.5lbs rr (2) SRX2
- 500354 Shock spring orange 1,8lbs astro (2) SRX2
- 500355 Shock spring red 1,9lbs astro (2) SRX2
- 500356 Shock spring pink 2,0lbs astro (2) SRX2
- 500357 Shock spring blue 2,1lbs astro (2) SRX2
- 500358 Shock spring purple 2,2lbs astro (2) SRX2
- 500359 Shock spring green 2,3lbs astro (2) SRX2

TRANSMISSION ASSEMBLY

SPURGEAR

- 500213 Spur gear 70T SRX2
- 500214 Spur gear 72T SRX2
- 500215 Spur gear 76T SRX2
- 500216 Spur gear 78T SRX2
- 500217 Spur gear 80T SRX2
- 500218 Spur gear 82T SRX2
- 500219 Spur gear 84T SRX2
- 500220 Spur gear 86T SRX2
- 500221 Spur gear 88T SRX2

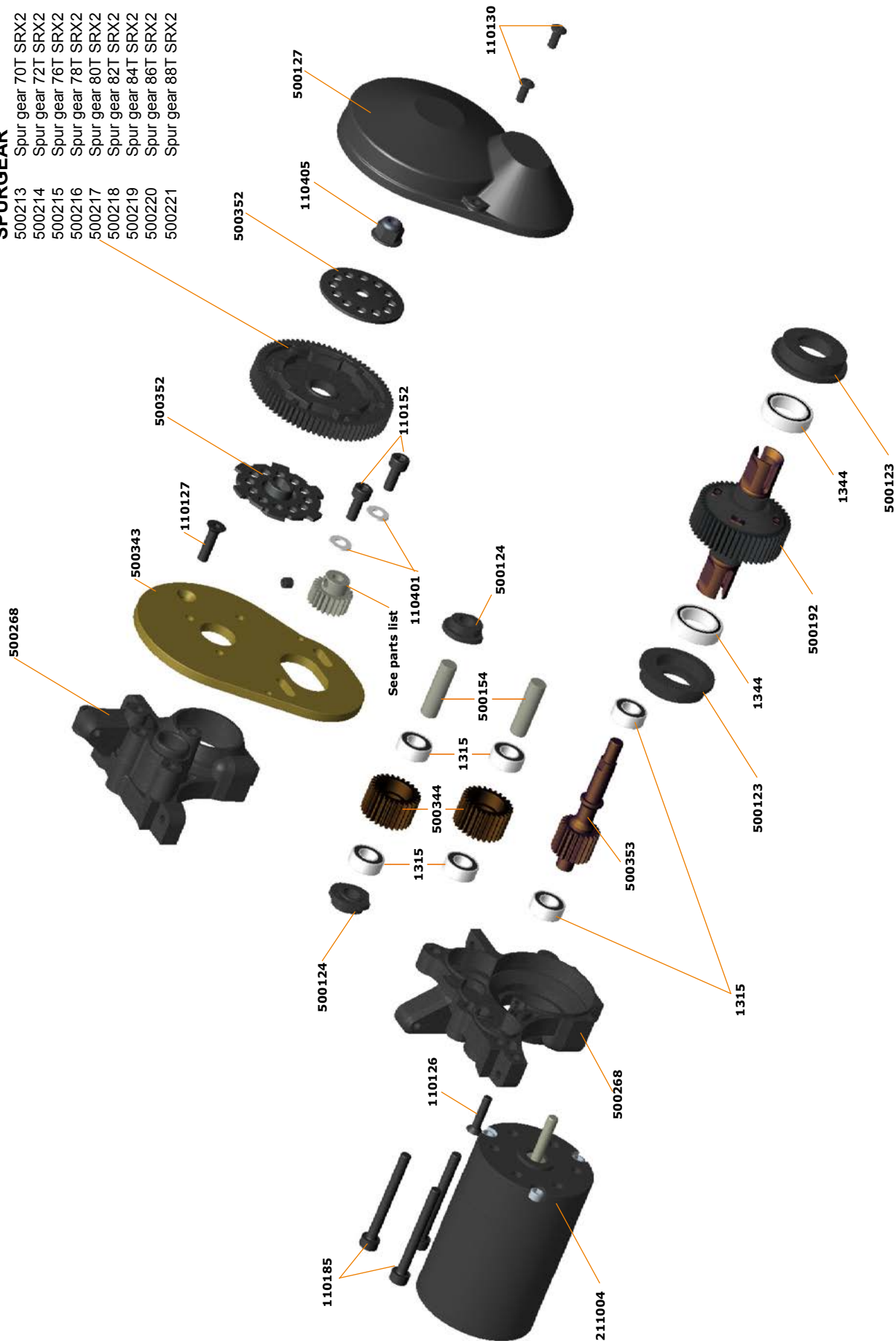

REAR ASSEMBLY

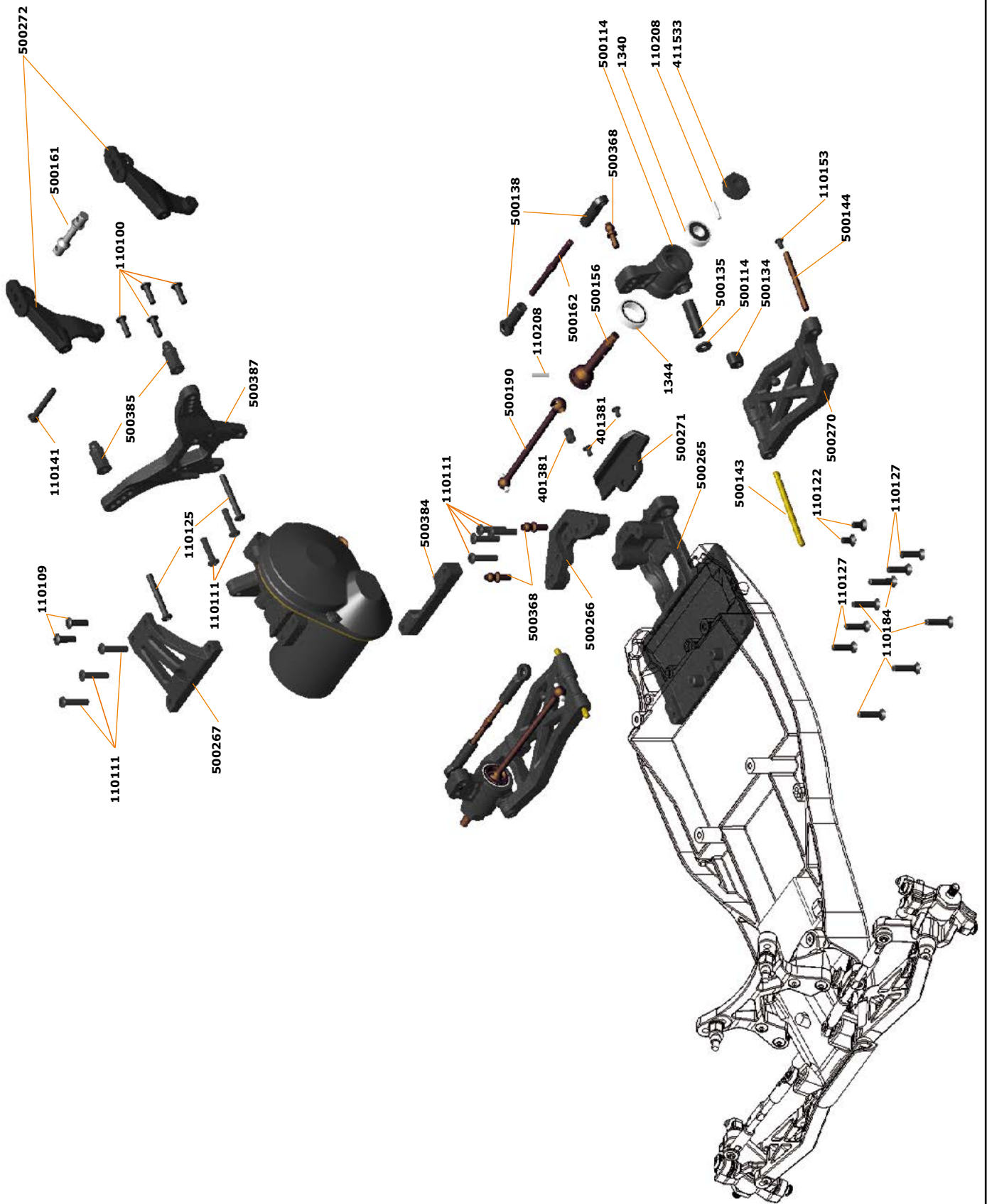

FINAL ASSEMBLY

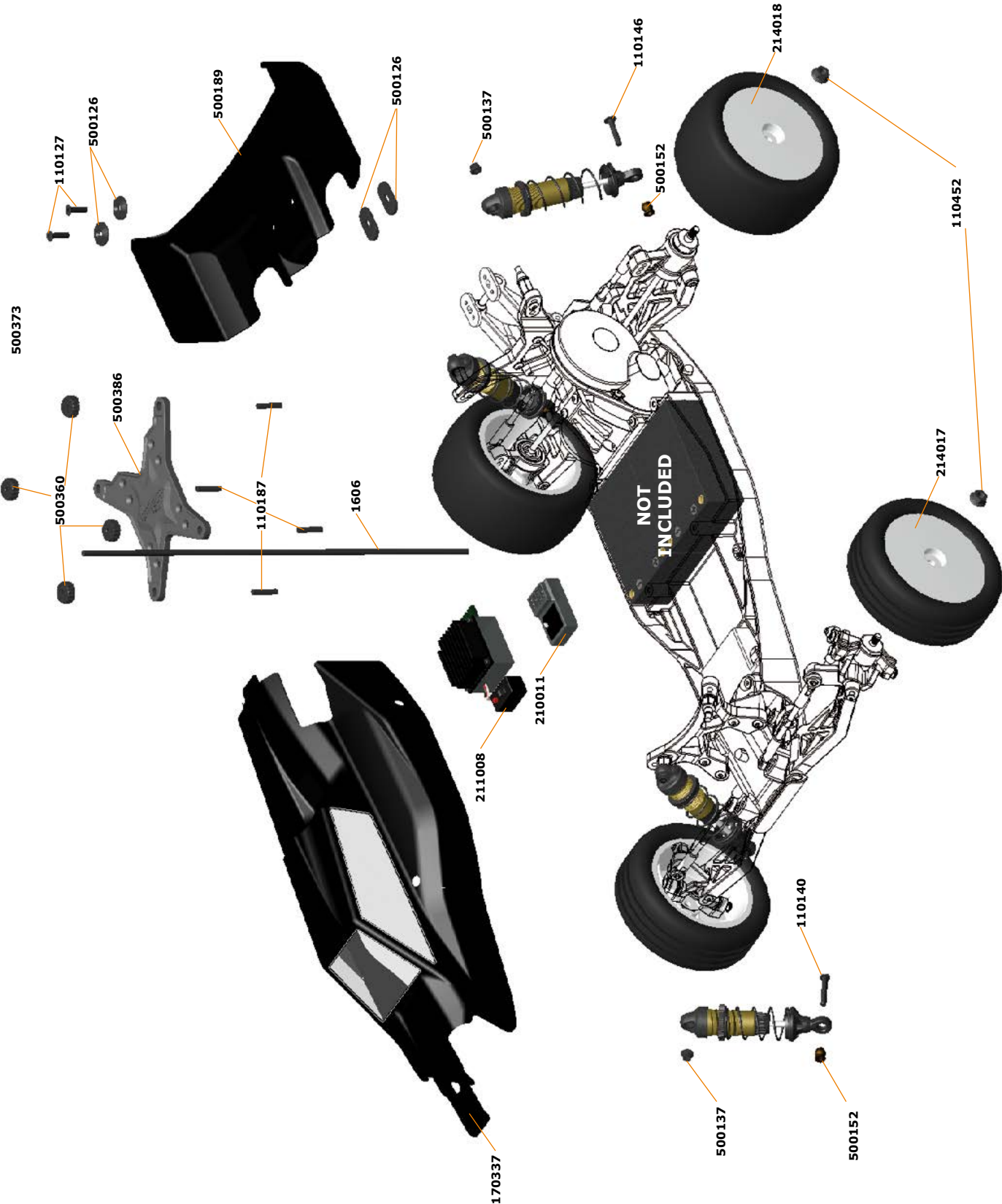

Optionals and Merchandising

Part no Description

RADIO INSTALLATION / BATTERY

500165 Battery plate nut (4) SRX2
 500278 Batteryplate carbon SRX2 MM
 500279 Battery holders (4) SRX2 MM
 500280 Battery plate foam SRX2 MM
 500284 Battery case inserts foam (3) SRX2 MM

SERVO SAVER AND STEERING

500147 Pivotball shim conical (10) SRX2
 500149 Pivotball with shaft med (5) SRX2
 500197 Servomount alu (2) SRX2
 500236 Steering rack alu (3) SRX2
 500287 Steering arm nr 1 brass L+R
 500288 Steering arm nr 2 brass L+R
 500289 Steering arm nr 3 brass L+R
 500152 Pivotball shock (4) SRX2
 500174 Shock body fr (2) SRX2
 500175 Shock body rr (2) SRX2
 500176 Shock top (2) SRX2
 500179 Shock top gasket (4) SRX2
 500180 Shock membrane (4) SRX2
 500199 Shock top bushing delrin (4) SRX2
 500201 Shock shaft fr TiN coated (2) SRX2
 500202 Shock shaft rr TiN coated (2) SRX2
 500238 Shock piston conical 2 holes (4) SRX2
 500239 Shock piston conical 3 holes (4) SRX3
 500240 Shock piston conical 4 holes (4) SRX4

SPRINGS

500222 Shock spring silver 2.5lbs fr (2) SRX2
 500223 Shock spring black 2.65 fr (2) SRX2
 500224 Shock spring orange 2.87lbs fr (2) SRX2
 500225 Shock spring red 3.0lbs fr (2) SRX2
 500226 Shock spring pink 3.15lbs fr (2) SRX2
 500227 Shock spring blue 3.4lbs fr (2) SRX2
 500228 Shock spring purple 3.5lbs fr (2) SRX2
 500229 Shock spring green 3.7lbs fr (2) SRX2
 500230 Shock spring orange 2.0lbs rr (2) SRX2
 500231 Shock spring red 2.1lbs rr (2) SRX2
 500232 Shock spring pink 2.2lbs rr (2) SRX3
 500233 Shock spring blue 2.3lbs rr (2) SRX2
 500234 Shock spring purple 2.4lbs rr (2) SRX2
 500235 Shock spring green 2.5lbs rr (2) SRX2

FRONT SECTION

500133 Steering rack bold (4) SRX2
 500139 Shocktower fr SRX2
 500146 Shock mount (4) SRX2
 500147 Pivotball shim conical (10) SRX2
 500148 Pivotball with shaft low (4) SRX2
 500149 Pivotball with shaft med (5) SRX2
 500150 Pivotball with shaft high (4) SRX2
 500151 Casterblock bushing (4) SRX2
 500104 1/10 buggy rim fr 2wd yellow (2)
 500193 Front wing set SRX2
 500194 Antiroll bar set fr SRX2
 500198 Pivotball with shaft short (4) SRX2
 500200 Front bulkhead inserts alu (6) SRX2
 500203 Pivot pin brace 20 deg fr SRX2
 500204 Pivot pin brace 30 deg fr SRX2
 500208 Antiroll bar fr 0.9 SRX2
 500209 Antiroll bar fr 1.0 SRX2
 500210 Antiroll bar fr 1.1 SRX2
 500237 C-hub L+R alu SRX2
 500241 Front wing SRX2
 500243 Front bulkhead alu SRX2
 500250 Front bulkhead brass SRX2
 500258 Antirollbar balljoints (2+2) SRX2
 500262 Pivot pin fr inner / rr outer TiN coated (2) SRX2
 500263 Pivot pin fr outer TiN coated (2) SRX2

MIDDLE SECTION

500165 Battery plate nut (4) SRX2
 500278 Batteryplate carbon SRX2 MM
 500279 Battery holders (4) SRX2 MM
 500280 Battery plate foam SRX2 MM
 500284 Battery case inserts foam (3) SRX2 MM
 500285 Ballast weight SRX2 MM

REAR SECTION

401387 Wheelhexagon (2)
 500147 Pivotball shim conical (10) SRX2
 500149 Pivotball with shaft med (5) SRX2
 500150 Pivotball with shaft high (4) SRX2
 500274 Suspension bracket rr fr SRX2 MM
 500275 Shocktower carbon rr SRX2 MM
 500276 Shock mount rr (2) SRX2 MM
 500106 1/10 buggy rim rr yellow (2)
 500196 Upright L+R alu SRX2
 500198 Pivotball with shaft short (4) SRX2
 500205 Antiroll bar rr 1.1 SRX2
 500206 Antiroll bar rr 1.3 SRX2
 500207 Antiroll bar rr 1.5 SRX2
 500211 Wheelhexagon +0.75mm offset (2)
 500212 Wheelhexagon -0.75mm offset (2)
 500244 Rear bulkhead weight SRX2
 500255 Suspension insert rr 3deg alu (2) SRX2
 500258 Antirollbar balljoints (2+2) SRX2
 500262 Pivot pin fr inner / rr outer TiN coated (2) SRX2
 500281 Antiroll bar set rr SRX2 MM
 500282 Wingmount low SRX2 MM
 500283 Suspension bracket rr fr brass SRX2 MM
 500286 Bumper rear brass SRX2 MM

TRANSMISSION

411069 Differential balls steel 1/8" (12)
 500153 Top shaft 21T SRX2
 500157 Slipper plate alu (3) SRX2
 500158 Slipper pad yellow (3) SRX2
 500159 Slipper spring (2) SRX2
 500160 Slipper bolt topshaft (2) SRX2
 500166 Idler gear 27T SRX2
 500167 Diff pully balldiff 51T (1) SRX2
 500168 Diff ring balldiff (2) SRX2
 500169 Balldiff outdrive male SRX2
 500170 Balldiff outdrive female SRX2
 500171 Balldiff spring (2) SRX2
 500172 Balldiff bolt (2) SRX2
 500173 Balldiff thrustbearing SRX2
 500186 Balldiff set SRX2
 500187 Balldiff T-nut (2) SRX2
 500277 Motor plate SRX2 MM
 600116 O-ring tank (4)
 411107 Diff balls. 1/8 ceramic (12)
 500242 Slipper plates vented alu (3) SRX2
 500256 Thrustbearing carbide balldiff SRX2
 500259 Differential balls carbide 1/8" (12)
 500260 Idler gear 27T alu SRX2

BODY AND WING

170336 Body Spyder 2wd MM 1/10 semipainted
 500241 Front wing SRX2
 500251 Rear wing 6.0" SRX2
 500252 Rear wing 7.0" SRX2

SPURGEAR

500213 Spur gear 70T SRX2
 500214 Spur gear 72T SRX2
 500215 Spur gear 76T SRX2
 500216 Spur gear 78T SRX2
 500217 Spur gear 80T SRX2
 500218 Spur gear 82T SRX2

- 500219 Spur gear 84T SRX2
- 500220 Spur gear 86T SRX2
- 500221 Spur gear 88T SRX2

PINIONS

- 120156 Motor-pinion alu hard 48P / 18T
- 120157 Motor-pinion alu hard 48P / 19T
- 120158 Motor-pinion alu hard 48P / 20T
- 120159 Motor-pinion alu hard 48P / 21T
- 120160 Motor-pinion alu hard 48P / 22T
- 120161 Motor-pinion alu hard 48P / 23T
- 120162 Motor-pinion alu hard 48P / 24T
- 120163 Motor-pinion alu hard 48P / 25T
- 120164 Motor-pinion alu hard 48P / 26T
- 120165 Motor-pinion alu hard 48P / 27T
- 120166 Motor-pinion alu hard 48P / 28T
- 120167 Motor-pinion alu hard 48P / 29T
- 120168 Motor-pinion alu hard 48P / 30T

TOOLS

- 190501 Tool-bag
- 190502 Carry-bag medium, 3 drawers
- 190508 Toolset for offroad (20pcs) with tools bag
- 190507 Toolset EP (16pcs) with Tools bag
- 190509 Allen wrench 1.5 x 120mm
- 190510 Allen wrench 2.0 x 120mm
- 190511 Allen wrench 2.5 x 120mm
- 190512 Allen wrench 3.0 x 120mm
- 190513 Ball driver hex wrench 2.0 x 120mm
- 190514 Ball driver hex wrench 2.5 x 120mm
- 190515 Ball driver hex wrench 3.0 x 120mm
- 190516 Tool tip allen wrench 1.5 x 120mm
- 190517 Tool tip allen wrench 2.0 x 120mm
- 190518 Tool tip allen wrench 2.5 x 120mm
- 190519 Tool tip allen wrench 3.0 x 120mm
- 190520 Tool tip ball driver hex wrench 2.0 x 120mm
- 190521 Tool tip ball driver hex wrench 2.5 x 120mm
- 190522 Tool tip ball driver hex wrench 3.0 x 120mm
- 190523 Turnbuckle wrench 3mm
- 190524 Turnbuckle wrench 4mm
- 190525 Turnbuckle wrench 5mm
- 190526 Flat head screwdriver 3.0 x 150mm
- 190527 Flat head screwdriver 4.0 x 150mm
- 190528 Phillips screwdriver 2.0 x 45mm
- 190529 Phillips screwdriver 3.5 x 120mm
- 190530 Phillips screwdriver 5.8 x 120mm
- 190539 Nut driver 4.5 x 100mm
- 190531 Nut driver 5.0 x 100mm
- 190532 Nut driver 5.5 x 100mm
- 190533 Nut driver 7.0 x 100mm
- 190534 Reamer with end cap for lexan body

MERCHANDISING

- 1896 Cap serpent black-orange
- 190172 Winter jacket Serpent black-orange hooded (M)
- 190173 Winter jacket Serpent black-orange hooded (L)
- 190174 Winter jacket Serpent black-orange hooded (XL)
- 190175 Winter jacket Serpent black-orange hooded (2XL)
- 190176 Winter jacket Serpent black-orange hooded (3XL)
- 190208 Winter jacket Serpent black-orange hooded (4XL)
- 190156 Polo shirt Serpent black (S)
- 190157 Polo shirt Serpent black (M)
- 190158 Polo shirt Serpent black (L)
- 190159 Polo shirt Serpent black (XL)
- 190160 Polo shirt Serpent black (XXL)
- 190161 Polo shirt Serpent black (XXXL)
- 190182 T-shirt Serpent Splash white (S)
- 190183 T-shirt Serpent Splash white (M)
- 190184 T-shirt Serpent Splash white (L)
- 190185 T-shirt Serpent Splash white (XL)
- 190186 T-shirt Serpent Splash white (XXL)
- 190187 T-shirt Serpent Splash white (XXXL)
- 190188 T-shirt Serpent Splash orange (S)
- 190189 T-shirt Serpent Splash orange (M)
- 190190 T-shirt Serpent Splash orange (L)

- 190191 T-shirt Serpent Splash orange (XL)
- 190192 T-shirt Serpent Splash orange (XXL)
- 190193 T-shirt Serpent Splash orange (XXXL)
- 190194 T-shirt Serpent Splash black (S)
- 190195 T-shirt Serpent Splash black (M)
- 190196 T-shirt Serpent Splash black (L)
- 190197 T-shirt Serpent Splash black (XL)
- 190198 T-shirt Serpent Splash black (XXL)
- 190199 T-shirt Serpent Splash black (XXXL)
- 190201 Hoody sweater Serpent black-zip (S)
- 190202 Hoody sweater Serpent black-zip (M)
- 190203 Hoody sweater Serpent black-zip (L)
- 190204 Hoody sweater Serpent black-zip (XL)
- 190205 Hoody sweater Serpent black-zip (2XL)
- 190206 Hoody sweater Serpent black-zip (3XL)
- 190207 Hoody sweater Serpent black-zip (4XL)
- 190215 T-shirt Serpent WC edition black (S)
- 190216 T-shirt Serpent WC edition black (M)
- 190217 T-shirt Serpent WC edition black (L)
- 190218 T-shirt Serpent WC edition black (XL)
- 190219 T-shirt Serpent WC edition black (XXL)
- 190220 T-shirt Serpent WC edition black (XXXL)



Transmitter, reciver,servo, parts

- 210004 Servo digital 0.14s/7,2kg
- 210006 Servo case for #210004
- 210008 Servo gear set for #210004
- 210009 Transmitter set DTS-2 with display 2.4 Ghz
- 210010 Transmitter DTS-2 with display 2.4Ghz
- 210011 Receiver DRS-2 on 2.4Ghz

Speed controller, motor, parts

- 211004 Motor brushless DL10 9T-3600kv
- 211008 Speedo DX-10 WP 45A
- 211011 Program card DX series

Tyres rubber offroad and wheels

- 214013 1/10 buggy rim fr 2wd white (2)
- 214014 1/10 buggy rim fr 2wd yellow (2)
- 214015 1/10 buggy rim rr white (2)
- 214016 1/10 buggy rim rr yellow (2)
- 214017 1/10 buggy Tyre mounted on white rim 2wd front (2)
- 214018 1/10 buggy Tyre mounted on white rim 4wd (2)

Weblink for :

- all spares: www.serpent.com/500006/spares
- all optionals: www.serpent.com/500006/optionals
- all tools: www.serpent.com/product/tools/
- all merchandising: www.serpent.com/product/Merchandising/
- all dragon-rc equipment: www.dragon-rc.com

Additions / notes

All rights reserved. Parts may change without prior notice.



SPYDER^{RTR} MID SRX²

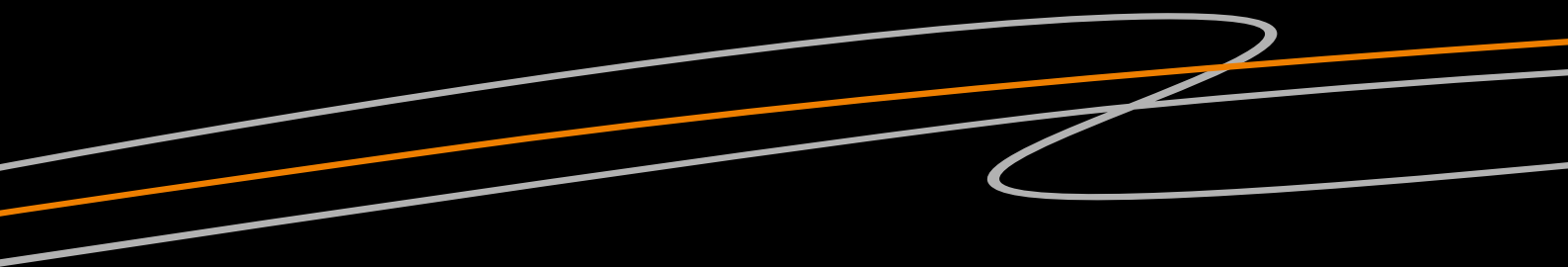

www.serpent.com - info@serpent.com



500006 Serpent Spyder Buggy SRX-2 MM 2wd 1/10 RTR